



DIA SINE®

**Redundant Sine Wave Power Inverter
GR300 Series 100V Model
User's Manual**



Ver.1.01E

Table of Contents

1. Safety Instructions	3
2. General Information	4
3. Features	5
3-1 Specification	5
3-2 De-rating Curve.....	6
3-3 Dimension	7
3-4 Control Panel	7
4. Installation and Wiring	8
4-1 Installation Guide	8
4-2 Wiring (Single)	9
4-3 Wiring (Parallel)	11
4-4 Checking the Current Setting	14
4-5 How to Start Up (single).....	14
4-6 How to Start Up (Parallel)	15
4-7 How to Power Off (Single)	16
4-8 How to Power Off (Parallel)	16
5. Functions	17
5-1 Change Settings	17
5-2 The Indicators of Setting during Operation.....	17
5-3 Operation Mode	18
5-4 Output Frequency	18
5-5 Output Voltage	18
5-6 Buzzer ON/OFF	18
5-7 LED Brightness.....	18
5-8 Sleep Mode.....	19
5-9 Protections.....	19
5-10 Remote Connector	22
5-11 Optional Terminal	22
6. LED Indicators	23
6-1 The LED Indicator in Normal Status.....	23
6-2 LED Indicators when Protection Activates.....	24
7. Troubleshooting Guide	25

1. Safety Instructions

This document contains important safety and operating information for DIASINE®. To get the most out of DIASINE®, use DIASINE® only as described in the safety instructions. Read the safety instructions carefully before installing DIASINE®.

 WARNING	<p>This sign indicates that the following contents includes important information. The wrong order of handling may result in death or serious injury.</p>
--	---

 CAUTION	<p>This sign indicates that the following contents includes important information. The wrong order of handling may cause damage to the products and the surrounding items.</p>
--	--

 MEMO	<p>This sign indicates that the following contents includes important information of manuals on functions that contain safety instructions or proper operation of DIASINE®.</p>
---	---

Installation Precautions

- Installation and operation of DIASINE® should be performed by personnel knowledgeable about proper safety precautions.
- To avoid the risk of electric shock and fire, read and follow the electrical wiring regulations. Do not disassemble DIASINE®.
- To avoid the risk of electric shock and fire, install DIASINE® out of the reach of children.
- Do not expose DIASINE® to rain, snow, dust or under high humidity environment.
- Do not install DIASINE® under high temperature environment, near fire or under direct sun exposure.
- The temperature of DIASINE® may rise during operation. Be careful when moving or removing it.
- To avoid covering or obstructing the ventilation openings, do not put any objects within 15cm (5.9in) area near DIASINE®.
- To avoid overheating, do not put anything on top of it.
- To connect more than one battery, use the same model of battery from the same manufacturer. Using different batteries at the same time is dangerous.
- Batteries produce explosive gases when discharged. Do not smoke or light fire near the battery.
- DIASINE® contains components that may cause arcs or sparks. To prevent fire or explosion, do not install in compartments with batteries or flammable materials.

 CAUTION	<p>Since battery deteriorates over time, maintenance on a yearly basis is recommended. Change deteriorated batteries to prevent the hazard of fire.</p>
--	---

					
Do Not Disassemble	Keep Dry	Danger High Temperature	No Open Flame	Do Not Stack	Keep Air Ventilation

2. General Information

DIASINE® GR series is a pure sine wave inverter that converts DC voltage to AC sine wave voltage and can connect up to 6 units in parallel. The output can be expanded up to 300VA x 6 units = 1800VA. Because of DENRYO's original synchronous control technology (patented), parallel output can be achieved by simply connecting the output terminals. Since the protection circuit works for each unit, even if one unit fails during operation, the output can continue. The output waveform is the same as the sine wave of commercial power supply. Total harmonic distortion is less than 3%. High efficiency circuit and switching control achieve 88-89% efficiency at full rated load. DIASINE® is downsized presented by fanless structure, cooling by natural convection, which enables it to operate quietly. In addition, DIASINE® is equipped with various protections. Even if the input polarity is reversed, the internal circuit will not be damaged. Moreover, with the capability of inputting wide voltage range, operating under wide temperature range and remote control function, DIASINE® can be used in various environments and applications.

Features

- Up to 6 units can be connected in parallel
- Synchronous control by simply connecting the output terminals
- Input reverse polarity protection by internal circuit
- Fanless quiet operation (natural convection)
- Wide operating temperature range (-20 to +60°C)
- Output voltage/frequency easily switchable by button
- Pure sine wave output (total harmonic distortion less than 3%)
- Light weight and slim design
- High efficiency 88-89% (at full rated load)
- Built-in remote-control function
- Various protections: Input voltage warning, shut down, input reverse polarity, output voltage, output short-circuit, overload and over temperature
- Buzzer ON/OFF, LED brightness switchable
- Sleep mode
- Wide input voltage range
- Input voltage of 12V/24V/48V by 3 lineups
- Input terminal cover for dust prevention
- Optional communication function (T. B. D.)

Block Diagram

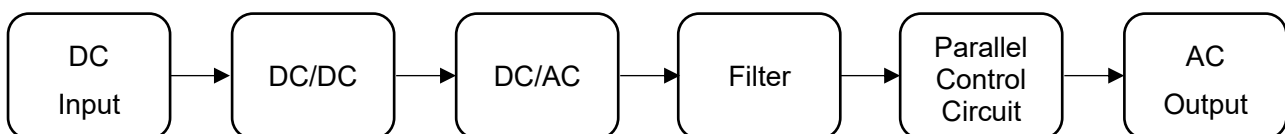

Safety and EMC Certified

Safety standards :EN62368-1: 2014+A11:2017

Immunity standards :EN55024:2010

Emission standards :EN55032:2012

3. Features

3-1 Specification

MODEL	GR300NA-112	GR300NA-124	GR300NA-148	
Input	Battery Voltage	12V	24V	48V
	Voltage Range*1	10.5-19.5Vdc	21-39Vdc	42-78Vdc
	Max. Current	33A	16A	8A
	No-load Current*2 (AC Outputting)	0.6A	0.2A	0.1A
	No-load Current*2 (AC Output disable)	0.3A	0.1A	<0.1A
	Standby Mode Consumption*2	8mA	7mA	4mA
	Sleep Mode Consumption*2	1mA	3mA	2mA
	Efficiency at Rated Load	88%	89%	89%
Output	Rated Power	300VA		
	Peak Power (3min.)	360VA (Refer to P.6)		
	Surge Power (3sec.)	420VA		
	AC Voltage (switchable)	100 default, 110/115/120Vac		
	Frequency (switchable)	50±0.1Hz default, 50/60Hz		
	Waveform	Sine Wave, <3%THD		
	Voltage Tolerance	±3.0%		
	LED indicators	Operating status, Battery voltage level, Output power level, Protection function, Operation setting		
Function	Remote-control	Output remote ON/OFF control terminal		
	Option terminal	Six-position four-conductor (6P4C) modular jack		
Protection	Input	Undervoltage, Overvoltage, Input reverse polarity		
	Output	Overload, Short-circuit, Output voltage error		
	Others	Over temperature (Detect by internal temperature sensors)		
Environment	Operating Temperature (Refer to P.6)	-20 to +30°C at rated load, +60°C at 60% load	-20 to +45°C at rated load, +60°C at 80% load	
	Operating Humidity	20-90%RH non-condensing		
	Storage Temperature/ Humidity	-30 to +70°C, 10-95%RH		
	Vibration	10-500Hz, 3G 10min./ 1cycle, 60mins. XYZ axes		
Safety & EMC	Safety Standards	Certified EN62368-1: 2014+A11:2017		
	Withstand Voltage	Battery I/P-AC O/P: 3.0kVac AC O/P-Ground: 1.5kVac Battery I/P-Ground: 1.5kVac		
	Isolation Resistance	Battery I/P-AC O/P: >1000MΩ/500Vdc/25°C/70% RH AC O/P-Ground: >1000MΩ/500Vdc/25°C/70% RH Battery I/P-Ground: >1000MΩ/500Vdc/25°C/70% RH		
	EMC Immunity	EN55024:2010		
	EMC Emission	EN55032:2012		
Others	Dimension (L×W×H)	234.0×146.5×44.0mm (9.213×5.768×1.732in)		
	Weight	0.9kg		

All parameters NOT specially mentioned are measured at 112:12Vdc, 124:24Vdc, 148:48Vdc input, 300VA rated load, power factor=1.0, 25°C of ambient temperature and under the default setting.

*1 Tolerance of voltage: 112: ±0.5V, 124: ±1V and 148: ±2V.

*2 Average.

3-2 De-rating Curve

• GR300NA-112

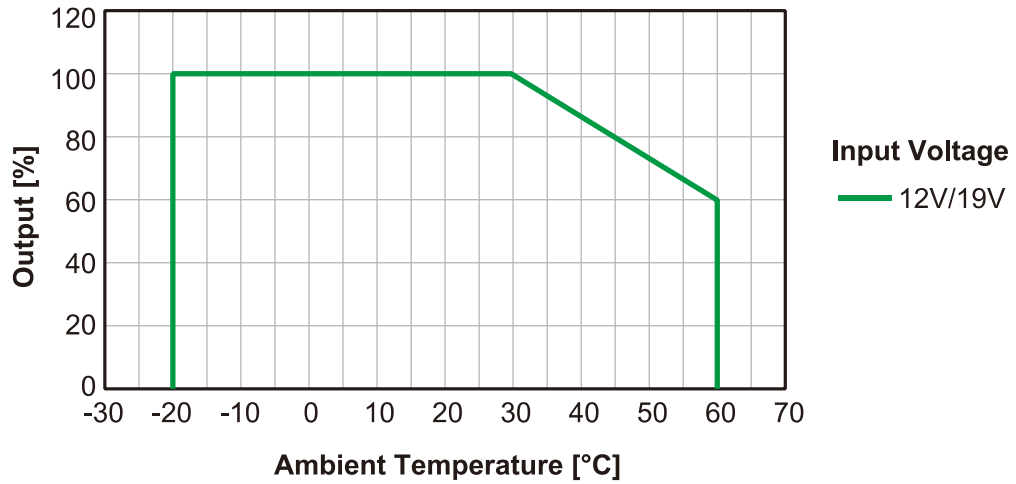

• GR300NA-124/148

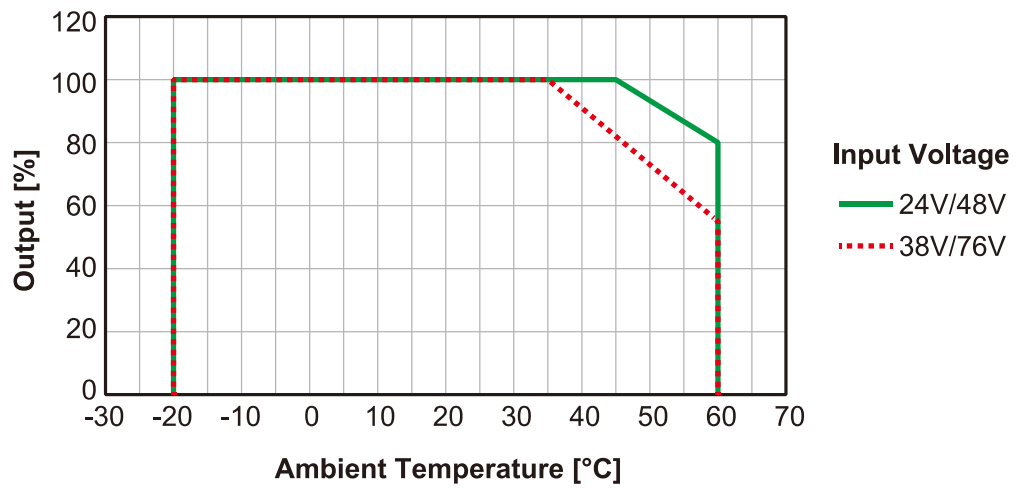

Depending on the environment, the over load protection or the over temperature protection may operate even in the range of the derating curve. For high rated power, please install DIASINE® in an environment with as good ventilation as possible.

3-3 Dimension

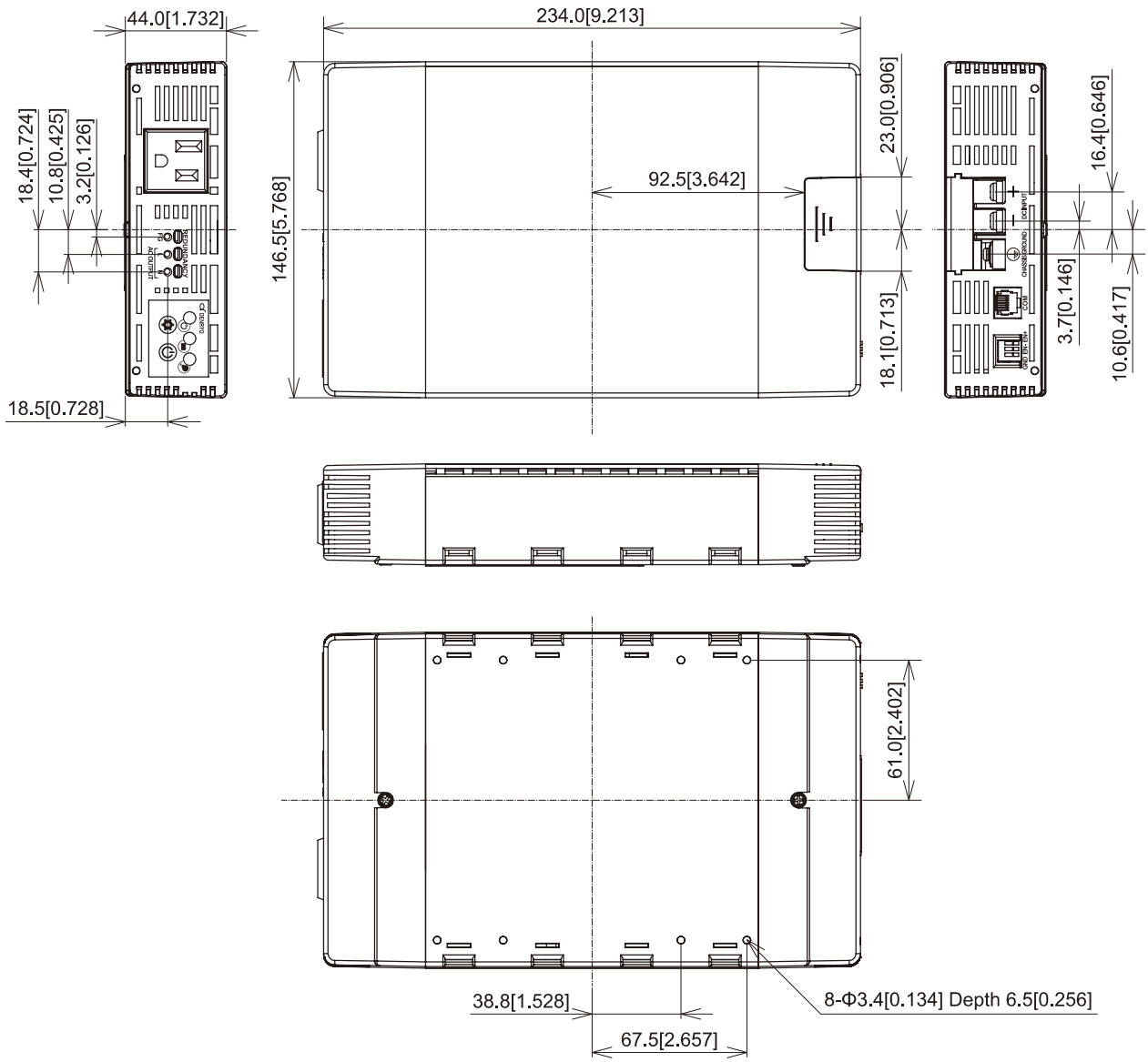

UNIT: mm [inch]

3-4 Control Panel

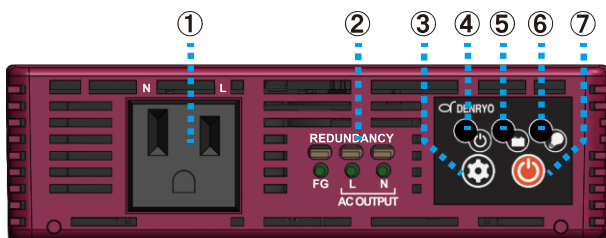

Front Panel

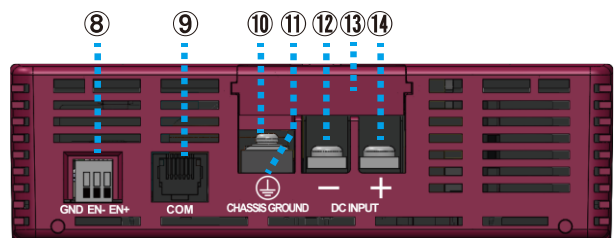

Rear Panel

①	AC Outlet	②	AC Output Terminal	③	Setting Button	④	Power LED
⑤	Battery LED	⑥	Load LED	⑦	Power Button	⑧	Remote Connector
⑨	Optional Terminal	⑩	Grounding Terminal	⑪	Reversed Connection Warning LED		
⑫	Battery Input (-)	⑬	Terminal Cover	⑭	Battery Input (+)		

4. Installation and Wiring

4-1 Installation Guide

Recommended Installation Location

Install DIASINE® on a flat surface or rack with sufficient strength. Avoid mounting and using in a dusty or high temperature environment. For ventilation, do not mount anything within 15cm (6in) area near the DIASINE®.

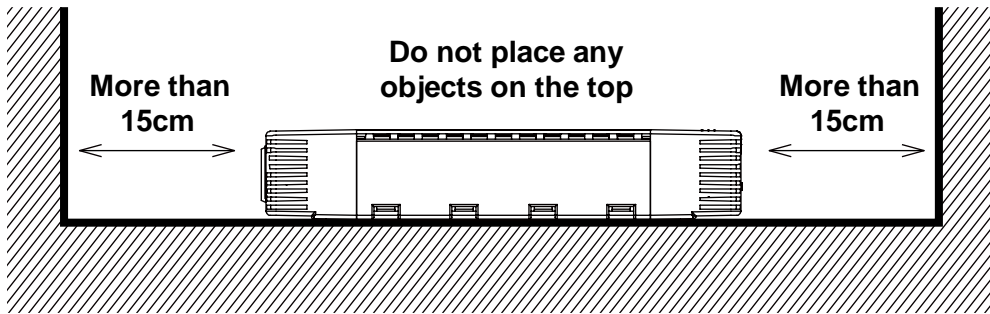



Figure 4.1 The Example of Installation

Recommended Installation Method

There are 8 mounting holes, $\Phi 3.4\text{mm}$ (0.134in), and depth 6.5mm (0.256in), in the bottom of DIASINE® (Refer to P.7) which can be used when installing DIASINE®. The recommended screw length is 6mm(0.236in). It is recommended to install DIASINE® horizontally on a flat surface.

 WARNING	Risk of Electric Shock and Damage Screws longer than the depth of the mounting holes may damage the internal circuit board and cause electric shock or malfunction.
--	--

 CAUTION	To avoid the risk of burns, do not touch anything other than the front panel of the DIASINE® during or immediately after use.
--	---

Table 4.1 Recommended Wiring Size

Terminal	Cable Size	Length	Screw Size	Terminal Width	Tightening Torque
Battery Input	AWG8 (10mm ²)	≤1.5m (59in)	M4	9mm (0.354in)	1.5Nm
Grounding	AWG10 (6mm ²)	-	M5	14mm (0.551in)	2.0Nm
AC Output	VVF1.6	≤3m (118in)	-	-	-
Remote Connector	AWG28-20 (0.08-0.5mm ²)	-	-	-	-

4-2 Wiring (Single)

Battery Wiring

Remove the terminal cover on rear side of the DIASINE®. Slide and push the terminal cover toward DIASINE® bottom to move it. Wire to the battery input terminal. Mount fuse in positive side cable. Refer to Table 4.2 to select fuse size based on system. Use the appropriate wire size for the battery input terminal. The screw size of the battery input terminal is M4; the width of the terminal is 9mm (0.354in). Recommended cable size at full rated load is 8AWG (10mm²) for GR300; recommended torque for installation is 1.5 N·m. Too thin a cable may cause overheating and fire. Recommended length of battery cable should be as short as possible within 1.5m (59in). After connecting to the battery, check that the Power LED on the front of the DIASINE® lights orange. If the power LED does not light up, check the battery voltage. In addition, the reversed connection warning LED near the ground terminal on the back of DIASINE® will light red if the polarity is reversed. Please correct the polarity and check if the warning LED turns off.

Table 4.2 Recommended Fuse Size

Model	Current
GR300NA-112	Under 40A
GR300NA-124	Under 20A
GR300NA-148	Under 10A

 WARNING	Explosion Hazard It is very dangerous to short-circuit the battery. Always wire the input terminal of the DIASINE® before connecting the battery.
--	--

Grounding Connections

Wire the grounding terminal in the rear of the DIASINE® to the system. The screw size of the grounding terminal is M5; the width is 14mm (0.551in). Use solderless terminals, such as R5.5-5, and fasten it with a screw. Recommended cable size is 10AWG (6mm²) and torque is 2.0 N·m.

Load Wiring

Connect the load from the AC outlet or AC output terminal in the front of the DIASINE®. Select a cable with the appropriate voltage rating for the AC output terminal. VVF1.6 cable is recommended. Peel off approximately 13-15mm (0.5-0.6in) of the cable jacket. Insert the cable into the hole marked AC OUTPUT on the front panel until the stripped portion is completely inserted. Make sure the line (L) and neutral (N) are not shorted. When removing the cable, insert a flathead screwdriver into the oval hole above the insertion hole and pull the cable out while pressing the flathead screwdriver.

 CAUTION	Terminal damage. The terminal may be damaged if the flat-blade screwdriver is pressed obliquely and forcefully.
--	--

 WARNING	Shock Hazard Make sure the core wire is fully inserted and not exposed. Make sure DIASINE® is not output when wiring the AC terminal.
--	--

Be careful NOT to short-circuit line (L) and neutral (L). Be sure to wire L and N correctly when wiring both the outlet and AC terminals of the DIASINE®.

Precautions About Load

Most loads can work on AC power supplied by DIASINE® GR series. However, some loads may not work even when keeping supplying with 300VA.

- (1) An extremely large current, about 6-10 times the rated power of the load, is required to start inductive loads or motors. DIASINE® cannot handle loads with peak current above the specification. Check the peak current required by the loads before selecting an inverter.
- (2) When connecting a capacitive load or a rectifier such as a switching power supply, do not activate the load and start DIASINE® at the same time to ensure complete startup of DIASINE®. Alternatively, start DIASINE® with a smaller load and then increase the load. If more than two loads are connected, activate one load at a time after DIASINE® starts outputting.

Remote Connector Wiring

Using the remote connector function in the rear of the DIASINE® (Refer to P.22), DIASINE® GR series can be started up or be turned to standby mode without pressing the power button. The recommended cable size for the remote connector is 20-28AWG (0.08-0.5mm²).

Optional Terminal Wiring

Optional terminal in the rear of the DIASINE® use a six-position four-conductor (6P4C) modular connector to adapt to various applications. Check DENRYO Official Website for more details.

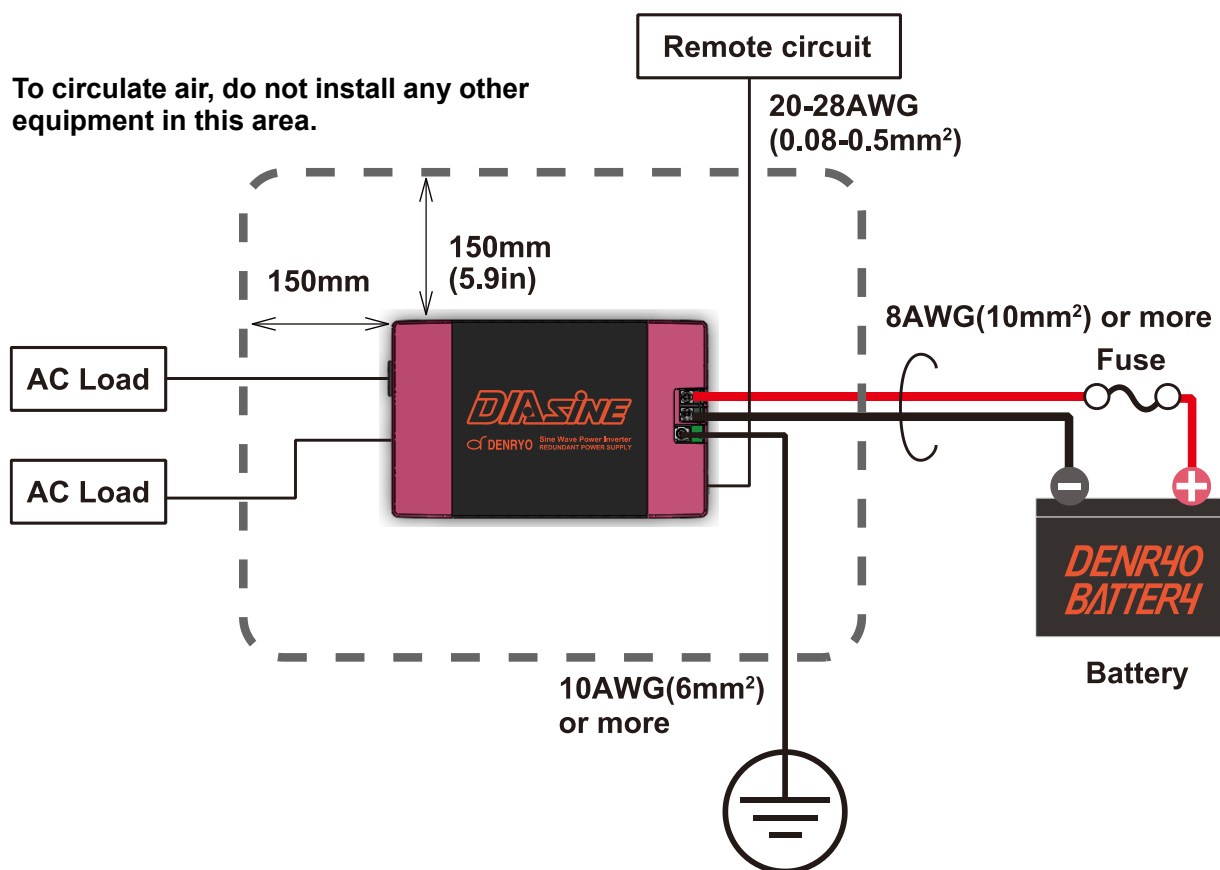



Figure 4.2 System Wiring Diagram

4-3 Wiring (Parallel)

Input Parallel Connections

 WARNING	Parallel connection is for GR series only. DO NOT connect in parallel with GD series or commercial power. In addition, the GR series CANNOT make a single-phase 3-wire or 3-phase system. Be sure to make parallel connections according to the procedure described in this section.
--	--

Remove the terminal cover on rear side of the DIASINE® GR series. Slide and push the terminal cover toward GR series bottom to move it. Wire all GR series battery input terminals. Use terminal blocks to collect all positive cables and negative cables to each block. Use the appropriate wire size for the battery input terminal. The screw size of the battery input terminal is M4; the width of the terminal is 9mm (0.354in). Recommended cable size at full rated load is 8AWG (10mm²) for GR300; recommended torque for installation is 1.5 N·m. Too thin a cable may cause overheating and fire.

Ground each grounding terminal if necessary. Refer to Table 4.2 to select fuse size based on system. Mount fuses in each positive cable between the battery input terminal and the terminal block. If necessary, also mount fuse between battery terminal and terminal block.

 MEMO	Battery input cables should be as short as possible and the same length between each GR series and the terminal block.
---	--

 WARNING	Explosion Hazard Check that each positive and negative cable terminal block is wired correctly before connecting to the battery. It is dangerous the positive and the negative terminals are touched when wiring battery.
--	---

 CAUTION	The output current of the GR series may be unbalanced and output less than the rated power if the battery input cable length of each GR series is very different or the input voltage of each GR series is different.
--	---

After connecting to the battery, check that the power LED on the front of the GR series lights orange. If the power LED does not light up, check the battery voltage. In addition, the reversed connection warning LED near the ground terminal on the back of GR series will light red if the polarity is reversed. Please correct the polarity and check if the warning LED turns off.

 CAUTION	It is recommended to connect all GR series to one battery array when connecting in parallel. Each GR series output may be unbalanced and output less than rated power when used in combination with different battery arrays or different input voltage models.
--	---

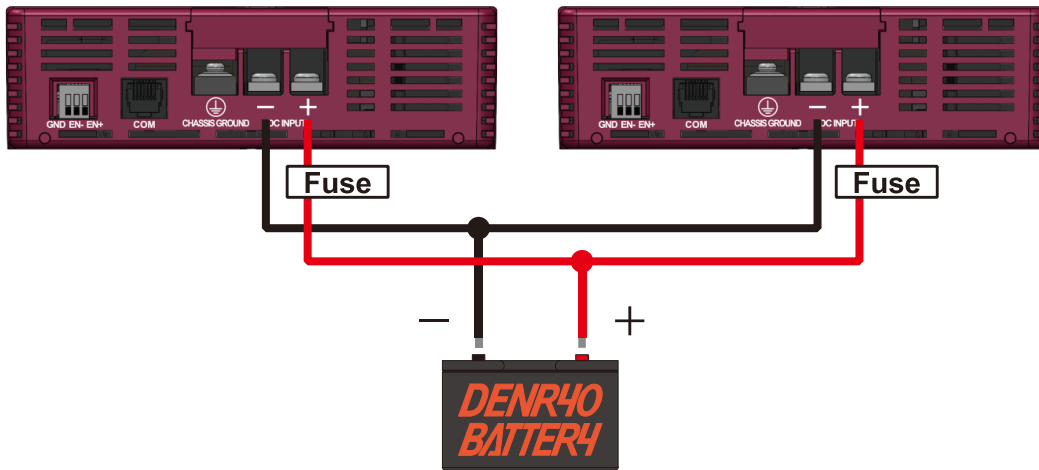

Figure 4.3 Input Parallel Connections

The recommended battery input cable length is less than 1.5m (59in). It is not necessary to make the positive and negative cables the same length, but as shown in Table 4.3 below, adjust the cable length so that the total cable length of both the positive and negative cables is the same for each GR series.

Table 4.3 The Example of Battery Input Cables Length for 3 Units GR in Parallel

Parallel Unit	Positive Cable Length	Negative Cable Length	Total Cable Length
GR(1)	1.5m	1m	2.5m
GR(2)	1m	1.5m	2.5m
GR(3)	1.25m	1.25m	2.5m

Output Parallel Connections

GR series can be connected in parallel up to 6 units. To connect in parallel, wire to the AC output terminals (or outlets) line (L) and neutral (N) of each GR series. Use terminal blocks to collect the all of line (L) cables and neutral (N) cables to each block.

 MEMO	AC output cables are recommended to be within 3m and should be the same length between each GR series and the terminal block.
---	---

 CAUTION	The GR series may be damaged if the line (L) and neutral (N) are short-circuited.
--	---

 WARNING	Shock Hazard DO NOT connect the GR series to commercial power.
--	---

 WARNING	Shock Hazard DO NOT wire the AC output when the GR series is outputting.
--	---



CAUTION

The GR series output may be unbalanced and output less than the rated power if the AC output cable length of each GR series is very different.



WARNING

Shock Hazard

For safety, DO NOT touch the AC output cables (plugs, exposed wires or terminal blocks, etc.) when even one of the GR series connected in parallel is in operation.

Load Wiring

Connect the load's line (L) and neutral (N) to the coupled line (L) and neutral (N) cables.

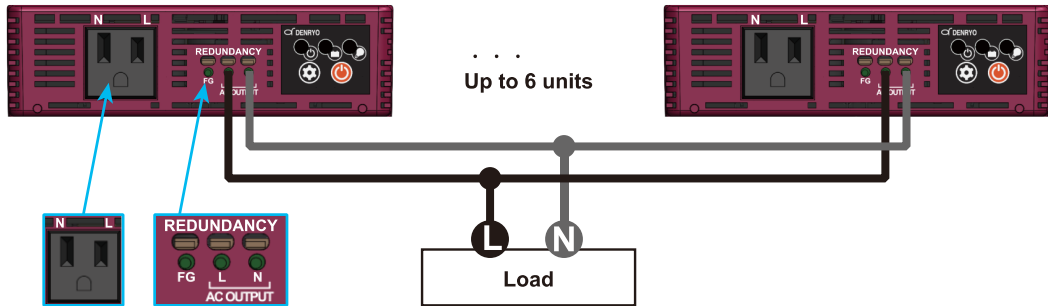

Figure 4.4 Output Parallel Connections

*1 Make the total cable length of lines and neutrals the same.

*2 Within 1.5m on one side. Make the total cable length the same.

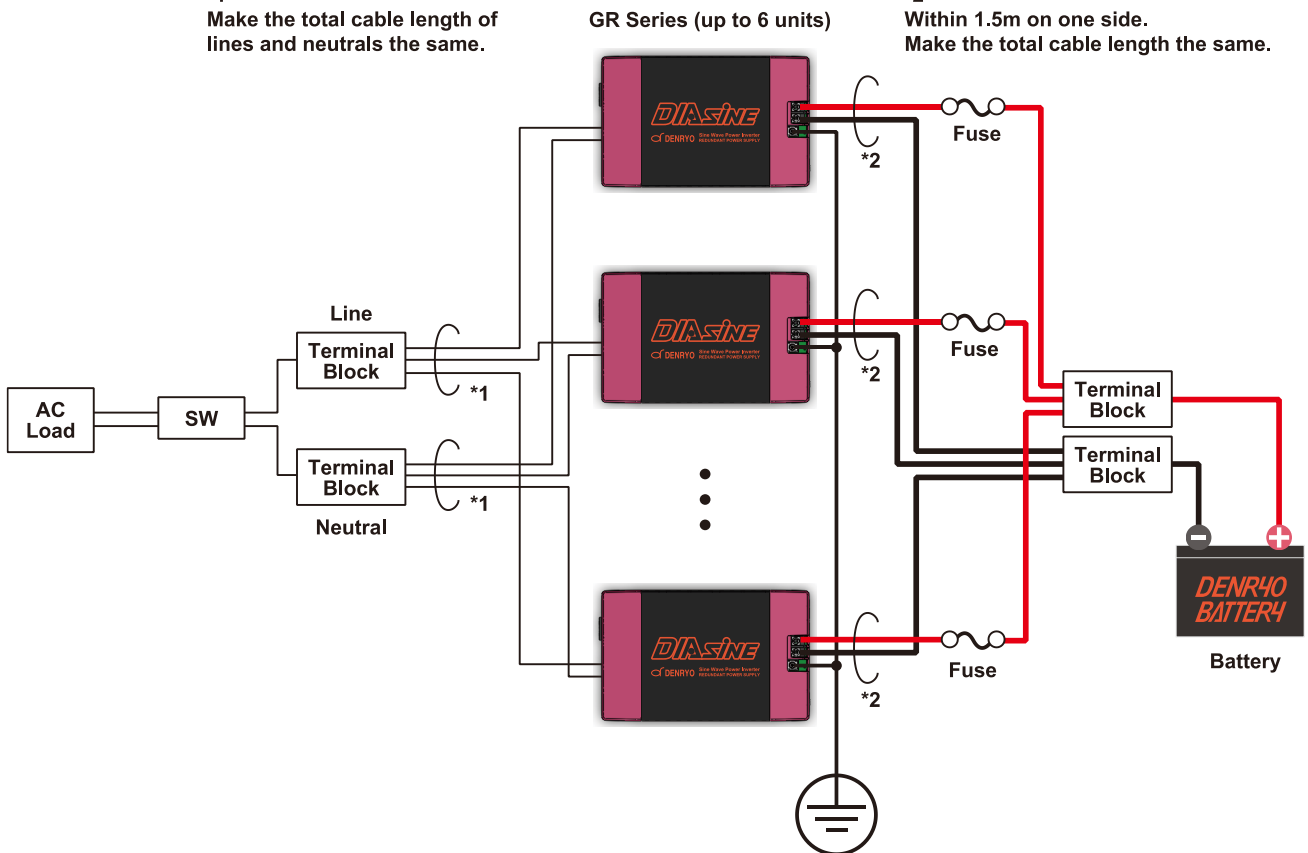

Figure 4.5 System Wiring Diagram (Parallel)

4-4 Checking the Current Setting

The default settings of the DIASINE® GR series are output voltage 100Vac, output frequency 50Hz, output disable mode, buzzer ON, and LED bright. Press setting button on the front panel to change settings (Refer to P.17). Settings are retained even if battery power is exhausted. In parallel operation, GR series cannot start if the output voltage and frequency setting are different. Make sure that all parallel units have the same setting.

4-5 How to Start Up (single)

Output Disable Mode

Press and hold the power button for 1 second. After the start-up sound, the power LED blinks green (blinks blue if start up by remote connector). This mode is output disable mode. In this mode, press the setting button and the power button simultaneously. The start-up sound sounds again, all LEDs light up, and output starts.

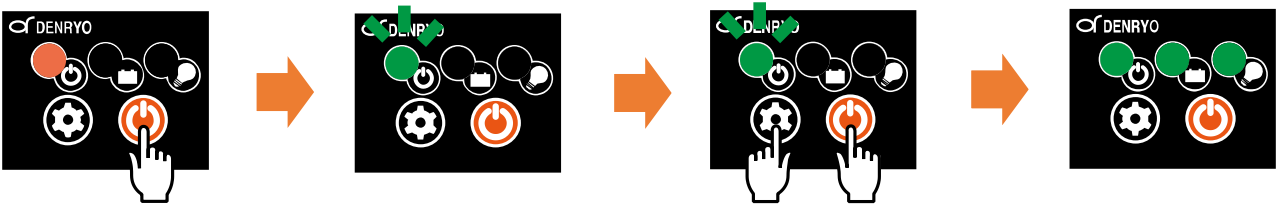

When the first power button is pressed and the output does not start for 10 minutes in this mode, the GR series will automatically return to standby mode.

Single Output Mode

Press and hold the power button for 1 second. After the start-up sound, the power LED blinks green for a few seconds. The start-up sound sounds again, all LEDs light up and start output automatically. The difference between single output mode and output disable mode is that in single output mode, the output will start automatically only by pressing the power button once.

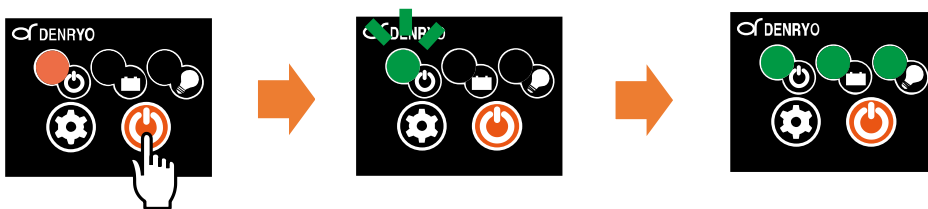

4-6 How to Start Up (Parallel)

Make sure that all parallel units have the same output voltage and frequency setting.

 CAUTION	For safety, please use the output disable mode for parallel operation.
--	--

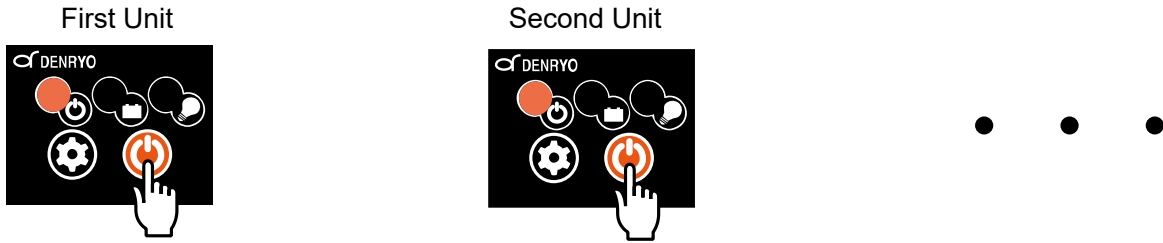

Press each GR series power button for about 1 second in any order. After the start-up sound, the power LED blinks green (blinks blue if start up by remote connector). This mode is output disable mode. In this mode, GR series do not output but detecting the parallel units each other. Check that all parallel units are under the output disable mode.

Press only ONE of GR series setting button and power button simultaneously.

The start-up sound sounds again, all LEDs light up and start output.

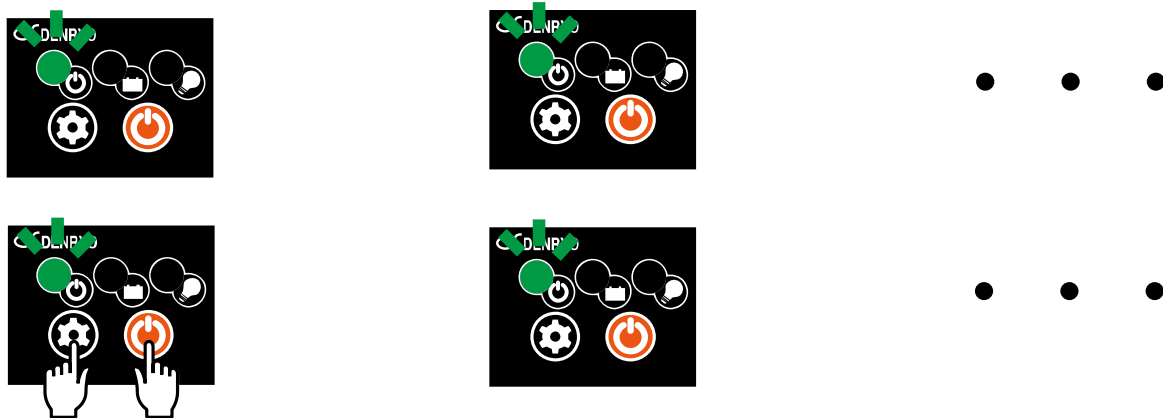

 CAUTION	DO NOT press 2 units or more setting buttons and power buttons at the same time. GR series may be damaged due to out of synchronization.
--	--

All parallel GR series also light up all LEDs and start output automatically.

The GR series which the buttons were pressed start output, other parallel GR series detect its output and then automatically start output and operate in parallel.



When using the single output mode for parallel operation, after pressing the power button of each GR series for about 1 second, all GR series will start outputting. Check the LED indicators to make sure that no protection circuit is operating(Refer to P.24), and then turn on the load.

4-7 How to Power Off (Single)

Press and hold the power button for 1 second. GR series will stop the output and switch to standby mode.

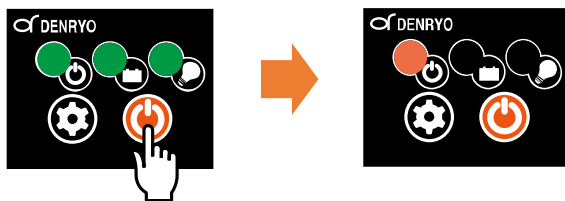

4-8 How to Power Off (Parallel)

 CAUTION	<p>Stop all loads connected to the GR series before turning off the GR series. The GR Series may be damaged if the power is turned off while loads are in operation.</p>
--	--

After stopping the loads, press and hold the power button of each parallel GR series in any order.



After the power button is pressed, the GR series will stop output and return to standby mode.

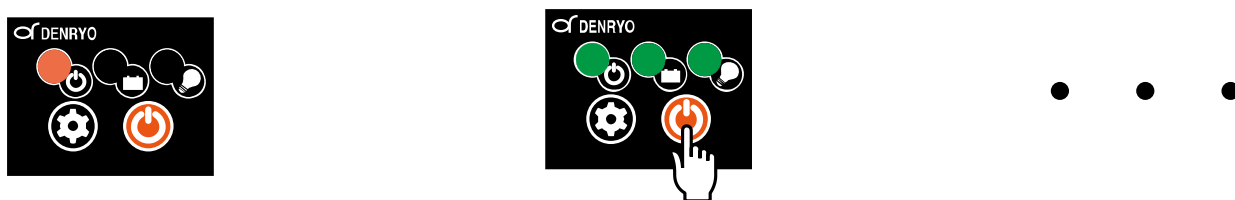

When all parallel GR series stop and return to standby mode, the power off procedure is completed.



 CAUTION	<p>If the load is powered on when parallel GR series are starting up, the first GR series may become overloaded and may not operate normally in parallel.</p>
--	---

5. Functions

5-1 Change Settings

1. After connected to the battery, DIASINE® is switched to standby mode. The power LED lights orange and other LEDs are off in standby mode. Do not connect anything to AC outlet and AC output terminal.
2. Pressing the setting button in standby mode will display the current setting for about 3 seconds. To change the setting, long press (for about 2 seconds) the setting button. The buzzer* sounds, and only the power LED lights. Release the setting button and proceed to the next step.
*DIASINE® does not sound once buzzer is set OFF.
3. Refer to Table 5.1, press the setting button to select the color of the power LED until it matches the output frequency and operating mode you selected. Long press the setting button. The buzzer* sounds, and only the battery LED lights. Release the setting button and proceed to the next step.
4. Refer to Table 5.1, press the setting button to select the color of the battery LED until it matches the output voltage you selected. Long press the setting button. The buzzer* sounds, and only the load LED lights. Release the setting button and proceed to the next step.
5. Refer to Table 5.1, press the setting button to select the color of the load LED until it matches buzzer setting ON/OFF and LED brightness you selected. Long press the power to complete setting process and back to standby mode. If long press the setting button, setting mode begins again from step 3.
6. Press the setting button. Check the setting is the same as the setting you selected.
7. The setting is saved even if the battery is removed.

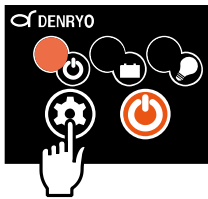

Operating	Description
Long-press the setting button	Standby mode to Setting mode
	Change the setting items
Press the setting button	Chose the parameter
Long-press the power button	Finish and save the settings

Figure 5.1 LED and Setting Button

Table 5.1 LED Color of Settings

LED		Power LED	Battery LED	Load LED
LED Color				
Green		50Hz, Output disable mode*	100Vac*	Buzzer ON, bright LED*
Yellow		60Hz, Output disable mode	110Vac	Buzzer ON, dark LED
Blue		50Hz, Single output mode	115Vac	Buzzer OFF, bright LED
Purple		60Hz, Single output mode	120Vac	Buzzer OFF, dark LED

*Default setting

5-2 The Indicators of Setting during Operation

It is possible to check the current settings during AC outputting by pressing the setting button, refer to Table 5.1. The settings cannot be changed during operation.

5-3 Operation Mode

The DIASINE® GR series has 2 operation modes. Set it in combination with the output frequency.

Output Disable Mode:

GR series output is disabled at start-up until an external output voltage is detected. When the GR series starts up by the power button, the power LED blinks green, the battery LED and load LED are off. When the GR series starts up by remote connector, the power LED blinks blue, the battery LED and load LED are off. When the GR series detected the external output voltage from other GR series in parallel, they check whether the output voltage and frequency are the same. If output voltage and frequency are the same, the GR series start outputting in sync. The power LED blinks red if out of synchronization. To start output under this mode, press the setting button and the power button simultaneously for about 1 second.



CAUTION

DO NOT press 2 units or more setting buttons and power buttons at the same time. GR series may be damaged due to out of synchronization.

Single Output Mode:

When GR series starts up by the power button or remote connector, it starts outputting after detecting whether there is any external output voltage from other GR series in parallel. When the GR series detected the external output voltage from other GR series in parallel, they check whether the output voltage and frequency are the same. If output voltage and frequency are the same, the GR series start outputting in sync. If output voltage and frequency are different, GR series are out of synchronization and the power LED blinks red.



CAUTION

DO NOT set 2 units or more GR series to single output mode and start up at the same time when connect in parallel. GR series may be damaged due to out of synchronization.

5-4 Output Frequency

The output frequency can be set in combination with the operation mode.

50Hz/60Hz: The default setting is 50Hz. Set all GR series to the same output frequency when connect in parallel.

5-5 Output Voltage

The output voltage can be set.

100V/110V/115V/120V: The default setting is 100V. Set all GR series to the same output voltage when connect in parallel.

5-6 Buzzer ON/OFF

The buzzer on/off can be set in combination with the LED brightness.

Buzzer on/off: The default setting is buzzer on. The buzzer sounds when the button is pressed, power on/off, warning and protections work. The warning buzzer sounds 3 beeps every 5 seconds, and sounds 5 beeps every 5 seconds when protections work. Set the buzzer off to disable all of these sounds.

5-7 LED Brightness

The LED brightness can be set in combination with the buzzer on/off.

LED bright/dark: The default setting is LED bright. The LED becomes darker when chose the LED dark.

5-8 Sleep Mode

DIASINE® switches to standby mode after connecting batteries; power LED lights orange and other LEDs light off. Under standby mode, hold power button and setting button simultaneously for 3 seconds, turns DIASINE® to sleep mode. Under sleep mode, all LEDs are off, power consumption can be suppressed more than standby mode. DIASINE® in sleep mode, is the same as in standby mode, can be activated by the power button or by the remote control connector. However, the settings cannot be confirmed or changed by pressing the setting button in sleep mode. Hold the power button and setting button again for 3 seconds turns DIASINE® back to standby mode. Disconnect the battery to cancel the sleep mode.



5-9 Protections

To prevent error operation, the DIASINE® GR series is equipped with protections listed below.

Input Reverse Polarity:

Reversed connection warning LED near the grounding terminal in the rear of the DIASINE® lights red when the battery polarity is reversed. Please reconnect to correct polarity.



Reversed Connection Warning LED

Input Undervoltage:

When the battery voltage is lower than the undervoltage warning value, the buzzer beeps 3 times consecutively around every 5 seconds. When the battery voltage is lower than the undervoltage shutoff value, DIASINE® automatically shuts off the output, buzzer beeps 5 times consecutively around every 5 seconds and the battery LED blinks red. When the battery voltage is higher than the undervoltage recovery value, DIASINE® automatically resumes output. The buzzer will not sound if the buzzer setting is off.

 MEMO	The undervoltage protection may work under conditions such as the load consuming too much power at the time of engine start. It may cause DIASINE® to shut off the output as the battery voltage drops.
---	---

Input Overvoltage:

When the battery voltage is higher than the overvoltage warning value, the buzzer beeps 3 times consecutively around every 5 seconds. When the battery voltage is higher than overvoltage shutoff value, DIASINE® automatically shuts off the output, buzzer beeps 5 times consecutively around every 5 seconds and the battery LED lights red. When the battery voltage is lower than the overvoltage recovery value, DIASINE® automatically resumes output. The buzzer will not sound if the buzzer setting is off.



CAUTION

Damage Hazard

Please choose battery within the DIASINE® input voltage range. If 12V battery is used with 24V model, the battery voltage is lower than input voltage range, DIASINE® will not work. Conversely, if 48V battery is used with 24V model, the battery voltage is higher than input voltage range, DIASINE® may be damaged.

Over Temperature:

When the internal temperature is higher than the over temperature warning value, the buzzer beeps 3 times consecutively around every 5 seconds. If the internal temperature continues to rise, the overtemperature protection is activated and DIASINE® automatically shuts off the output, the buzzer beeps 5 times consecutively around every 5 seconds and the power LED lights red. When the internal temperature drops below the value, DIASINE® automatically resumes output.

Output Voltage Error:

When the AC output voltage is too high or too low, DIASINE® shuts off the output, the buzzer beeps 5 times consecutively around every 5 seconds, and the load LED lights red. To cancel the error status, please restart DIASINE®.

Internal Voltage Error:

If the internal voltage becomes higher than specified, such as when the DIASINE® repeatedly starts, stops and starts when the battery voltage is higher than the overvoltage warning, the protection will be activated. To cancel the error status, stop the DIASINE®, wait a few tens of seconds, and then restart the DIASINE®.

Output Short-circuit:

When the output terminal is short-circuited or the load suddenly increases, DIASINE® stops the AC output, the buzzer beeps 5 times continuously every 5 seconds, and the load LED lights red. To cancel this protection, please restart DIASINE®.

Overload:

The overload protection works in either of the 2 conditions described in Table 5.2. One is 100%-120% of rated power and continues for about 3 minutes or more. The other is output more than 120% of rated power and continues for about 3 seconds. When the overload protection is activated, the DIASINE® stops the AC output and the buzzer beeps 5 times consecutively every 5 seconds and the load LED lights red. To cancel this protection, please restart DIASINE®.

Table 5.2 The conditions of overload protection

Overload Protection	load	Output Time
Condition 1	100%-120%	3 minutes or more
Condition 2	More than 120%	3 seconds or more

Abnormal Output:

Abnormal output works when GR series detected the external output voltage from other GR series in parallel and found the output voltage and frequency are different. The power LED blinks red and no buzzer sounds during abnormal output. Set all parallel GR series to the same output voltage and frequency to cancel this error.

Output Disable Protection:

If the GR series does not start the output for 10 minutes after switching to output disable mode, it will return to standby mode automatically to protect battery. Start up the output within 10 minutes after switching GR series to the output disable mode.

 MEMO	Protections can be canceled by turning DIASINE® on/off via the remote connector. Find out the possible causes of the protections work. Remove these faults first before restarting DIASINE®.
---	--

Refer to Table 5.3 for input voltage setting values of protections. Also, refer to Table 6.4 for LED indicators when protections are operating.

Table 5.3 The Input Voltage Setting Value of Protection

Model	Input Undervoltage			Input Overvoltage		
	Warning	Shut off	Resume	Warning	Shut off	Resume
112	11.5Vdc	10.5Vdc	12.5Vdc	18.5Vdc	19.5Vdc	18.5Vdc
124	23.0Vdc	21.0Vdc	25.0Vdc	37.0Vdc	39.0Vdc	37.0Vdc
148	46.0Vdc	42.0Vdc	50.0Vdc	74.0Vdc	78.0Vdc	74.0Vdc

When warnings or protections are operating, the buzzer could be turned on/off temporarily by pressing setting button. If the buzzer was turned off by this method, the buzzer will beep again when other warnings or protections are working. In addition, even the warning status is cancelled, the buzzer will beep again when it returns to warning status.

Example 1. Undervoltage warning is working and buzzer is beeping. Press the setting button to turn off the buzzer. When DIASINE® shuts off due to undervoltage protection, the buzzer will beep again.

Example 2. Over temperature warning is working and buzzer is beeping. Press the setting button to turn off the buzzer. After temperature drops and the warning released, the buzzer will beep again when the temperature warning is working again.

Change the setting to disable the buzzer (Refer to P.17).

If the AC output is stopped by the protections, such as input undervoltage, input overvoltage and over temperature, DIASINE® will automatically recover. For other errors, manual recovery (power OFF and ON) is required. Table 5.4 shows how GR series behaves after auto recovery. Output is resumed after auto recovery under the single output mode. On the other hand, the output does not resume after auto recovery under output disable mode, but the output of the unit that started by pressing the setting button and power button resumes after auto recovery as in single output mode.

In parallel operation, GR series may not recover if a load is connected. This is because all GR series do not resume output at the same time. They start output with a time lag in parallel operation. If a load is

connected while the GR series is starting output, they may not be synchronized. If GR series do not recover, remove the load and reconnect the load after all GR series have resumed output.

Table 5.4 Protections and Auto Recovery

Operation Mode	Single		Parallel		
	Output Disable	Single Output	Output Disable	Output Disable (Start-up Unit)	Single Output
Input Undervoltage	Auto recovery and output resumes.		Auto recovery but no output.	Auto recovery and output resumes*.	
Input Overvoltage					
Over Temperature					
Overload	Manual recovery is required.				
Output Short-circuit					
Output Voltage Error					
Internal Voltage Error					
Internal Error					

* GR series may not recover if a load is connected.

5-10 Remote Connector

As the Figure 5.2 method 1, connect the battery (+) to the ENABLE+ (EN+) terminal of the remote connector can start up the DIASINE® GR series. **If the GR series is in the output disable mode after start-up, it waits until an external output voltage is detected. If in the single output mode, GR series starts output.** When ENABLE+ (EN+) is removed, the GR series enters standby mode or sleep mode. As the Figure 5.2 method 2, connect the ENABLE- (EN-) terminal and the GND terminal can start up GR series. Disconnect EN- terminal and GND terminal, GR series enters standby or sleep mode. GR series can be operated by either method 1 or method 2. The power LED lights blue when GR series is turned ON by remote connector. If the power button is pressed when the GR series has been turned on by remote connector, the GR series can enter standby mode or sleep mode, and cannot be turned on again until remote connector is disconnected.

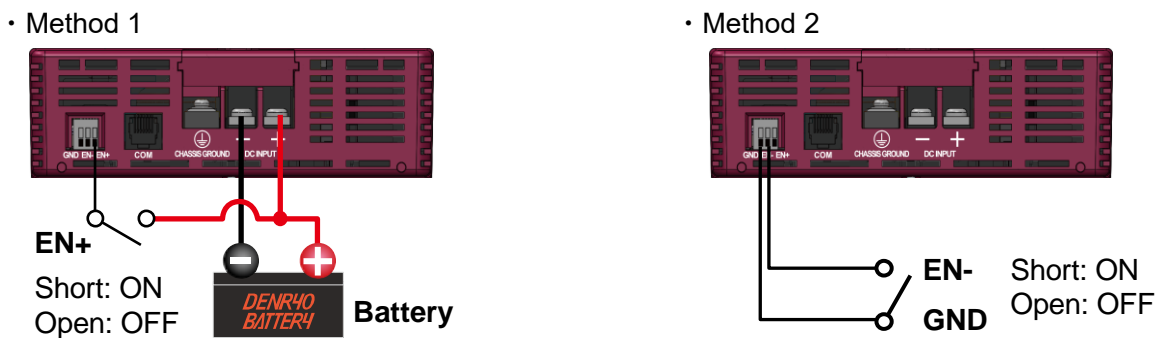

Figure 5.2 The Wiring of Remote Connector

5-11 Optional Terminal

DIASINE® can achieve various applications by using optional terminals on the rear of panel. Check DENRYO Official Website for more details.

6. LED Indicators



MEMO

The blinking frequency of each LED indicator is once every two seconds, repeat on and off.

6-1 The LED Indicator in Normal Status

Power LED: The power LED indicates output ON/OFF status or over temperature warning status. Refer to Table 6.1 for LED color and status indicators.

Table 6.1 Power LED Indicators

LED Colors		LED	Power LED
Orange			Standby
Orange Blink			Standby/ Sleep (Turned ON by remote connector*)
Green			Power ON
Blue			Power ON (Remote is operating)
Yellow Blink			Over temperature warning

*When DIASINE® is turned ON by the remote connector, and turned OFF by the power button, the power LED blinks orange. In this case, the output cannot be turned on until the remote connector is removed once. The power LED also [blinks orange in sleep mode.





Battery LED: The Battery LED indicates the voltage value of the battery during operation. Refer to Table 6.2 for LED color and battery voltage indicators. For battery voltage values on 124 and 148 models, multiply the values listed below by 2 or 4.

Table 6.2 Battery LED Indicators

LED Colors		LED	Battery LED
Yellow Blink			Input voltage 10.5-11.5Vdc (Input Undervoltage Warning)
Yellow			Input voltage 11.5-12.0Vdc
Green			Input voltage 12.0-14.0Vdc
Blue			Input voltage 14.0-16.5Vdc
Purple			Input voltage 16.5-18.5Vdc
Purple Blink			Input voltage 18.5-19.5Vdc (Input Overvoltage Warning)

Load LED: The Load LED indicates the percentage of output power during operation. Refer to Table 6.3 for LED color and percentage output power indicators.





Table 6.3 Load LED Indicators

LED Colors		LED	Load LED
			
Blue			0-40% output power
Green			40-70% output power
Yellow			70-100% output power
Yellow Blink			Over than 100% output power (Overload Warning)

6-2 LED Indicators when Protection Activates

When the protection is operating, the LED indicates the status of the protection and the output shutoff. Refer to Table 6.4 for the LED indicators and status of the protections.

Table 6.4 The Indicators of Protections

Lighting LED		Power LED	Battery LED	Load LED	All LED
					
Red Blink		Abnormal output	Input undervoltage	AC output error	Internal voltage error
Red		Over temperature	Input overvoltage	Overload/Load terminal short-circuited	Internal error*

* If the internal error occurs, remove the load, and check that the input voltage is within the normal range. Please contact your dealer if the internal error still occurs.

7. Troubleshooting Guide

Error Condition	Possible Cause	Solution
No AC output voltage	Input voltage error Battery LED lights / blinks red	Check the DC input voltage and make sure the input voltage is within the specification.
	Over temperature protection Power LED lights red	Check if ventilation is blocked or air temperature is too high. Reduce the load capacity or lower the air temperature around the DIASINE®.
	Overload protection Load LED lights red	Check whether the load capacity and the instantaneous value exceed the rated power of the DIASINE® or not.
	Short-circuit protection Load LED lights red	Check whether the load wiring is short-circuited or not.
	AC output terminal wiring problem	Check that the wiring to the AC output terminal is correct or not.
	Abnormal output Power LED blinks red	Set all parallel GR series to the same output voltage and frequency.
	Internal error All LEDs light / blink red	Internal parts of DIASINE® may be damaged. Please contact the dealer.
Short operation time of DIASINE®	Battery problem	Please replace the battery.
	Lack of battery capacity	Please check the battery specifications and increase the battery capacity.
Load LEDs show differently in parallel operation	Input voltage or input/output cable length are different	Due to the output error between parallel units, the color of the load LEDs may mix green and blue, or green and yellow. If the colors are blue and yellow, check and make each GR series input voltage and cable length the same.
Output voltage, frequency error	Wrong setting	Change the settings (Refer to P.17)
Power LED does not light up even connecting battery	Reversed connection of battery polarity Reversed connection warning LED lights red	Reconnect the correct polarity
	Internal fuse cuts off	Internal parts of DIASINE® may be damaged. Please contact the dealer.
	Under sleep mode	Press and hold the power button and setting button for 3 seconds. If LED still does not light, disconnect battery and reconnect after 5 seconds.
Remote connector does not work	Wiring problem	Check that the remote connector is properly connected.
Unusual noises when loads operate such as radio	Switching noise	Try the methods* below to reduce noise: 1. Keep DIASINE® away from loads 2. Wire grounding terminal 3. Install appropriate line filter circuit

* Effect may differ depending on environment or device.

If the error condition cannot be solved, please consult the dealer.



28-5, Nishinippori 2Chome, Arakawa-ku,
Tokyo 116-0013, Japan
Phone : +81-3-3802-3671
FAX : +81-3-3802-2974
Email: info-en@denryo.com
www.denryo.com/en

DM-5514